

Ulefos Esco ventil T-rør AQ3

Serienr. 20-04

Bruksområde og tekniske egenskaper

- Bruksområde: Drikkevann
- Trykkklasse: PN16
- Leveres standard høyrelukkende. Kan også leveres venstrelukkende
- Standardboring PN10/16 (EN 1092-2)
- Designstandard ihht: EN 1171, EN 12516-3, ISO 7259, EN 1074-1 og 2 ,
- **Leveres standard med AISI420 spindel.** Kan også leveres med også med Duplex 22Cr eller AISI 316 spindel. Se tabeller for de ulike variantene
- Sluse : syrefast stål AISI 316
- Tetningsinnsats i TPR - (termoplastisk gummi)

AQ3 Ventil T med brannventilavstikker og serviceventiler, HL

Med brannventilavstikker og serviceventiler

NRF nr.	DN mm	Flense-boring	H mm	L mm	L1 mm	C	A mm	Vekt kg	Ulefos ref.nr
5505562	100	PN10/16	331	580	290	389	212	66,4	4740 111 00 100 0
5505563	150	PN10/16	418	620	310	390	360	116,0	4740 111 00 150 0
5505564	200	PN10	573	750	375	480	445	186,2	4740 111 00 200 0
5505565	200	PN 16	573	750	375	480	445	188,2	4740 111 00 201 0

Leveres også venstrelukkende .

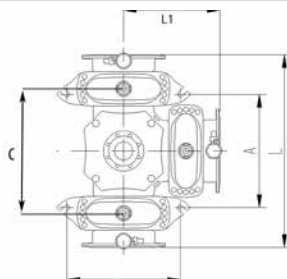
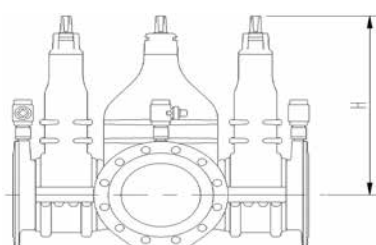

AQ3 Ventil T med brannventilavstikker, HL

Med brannventilavstikker uten serviceventiler

NRF nr.	DN mm	Flense-boring	H mm	L mm	L1 mm	C	Vekt kg	A mm	Ulefos ref.nr
5505602	100	PN10/16	331	580	290	389	63,4	212	4742 111 00 100 0
5505603	150	PN10/16	418	620	310	390	112,5	360	4742 111 00 150 0
5505604	200	PN10	573	750	375	480	182,7	445	4742 111 00 200 0
5505605	200	PN 16	573	750	375	480	182,1	445	4742 111 00 201 0

Leveres også venstrelukkende

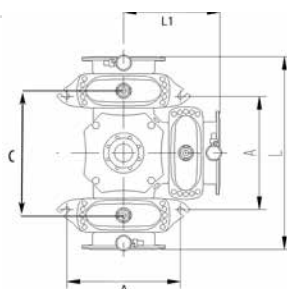
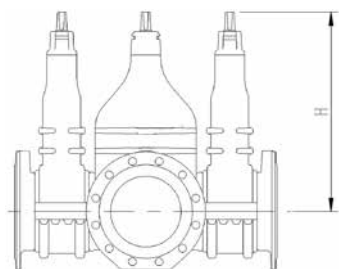

Ulefos AS påtar seg ikke ansvar for eventuelle feil i sine datablader, brosjyrer eller annet trykket materiale. Ulefos AS forbeholder seg rett til konstruksjonsendringer av sine produkter uten forvarsel. Dette gjelder også produkter som inngår i allerede definerte ordre under forutsetning av at avtalte spesifikasjoner ikke endres. Samtlige varemerker i dette materialet er respektive firma sin eiendom.

Aquosus® sluseventiler AQ3

Serienr. 20-04

AQ4 Ventil kryss med brannventilavstikker, serviceventiler og reduksjon i kl.3 og kl.9

NRF nr.	DN mm	Boring	H mm	L mm	L1+L2 mm	C	A mm	Vekt kg	Ulefos ref.nr
5505649	100 x 80	PN10/16	331	580	640	389	212	84	4755 111 42 100 0
5505651	150 x 100	PN10/16	418	620	681	390	360	140,5	4755 111 43 150 0
5505652	200 x 150	PN10	573	750	809	480	445	226,4	4755 111 44 200 0
5505653	200 x 100	PN10	573	750	809	480	445	222,4	4755 111 45 200 0
	200 x 150	PN16	573	750	809	480	445	226,4	4755 111 44 201 0
	200 x 100	PN16	573	780	809	480	445	222,4	4755 111 45 201 0

Leveres også venstrelukkende



Aquosus® en modulær løsning med utallige valgmuligheter

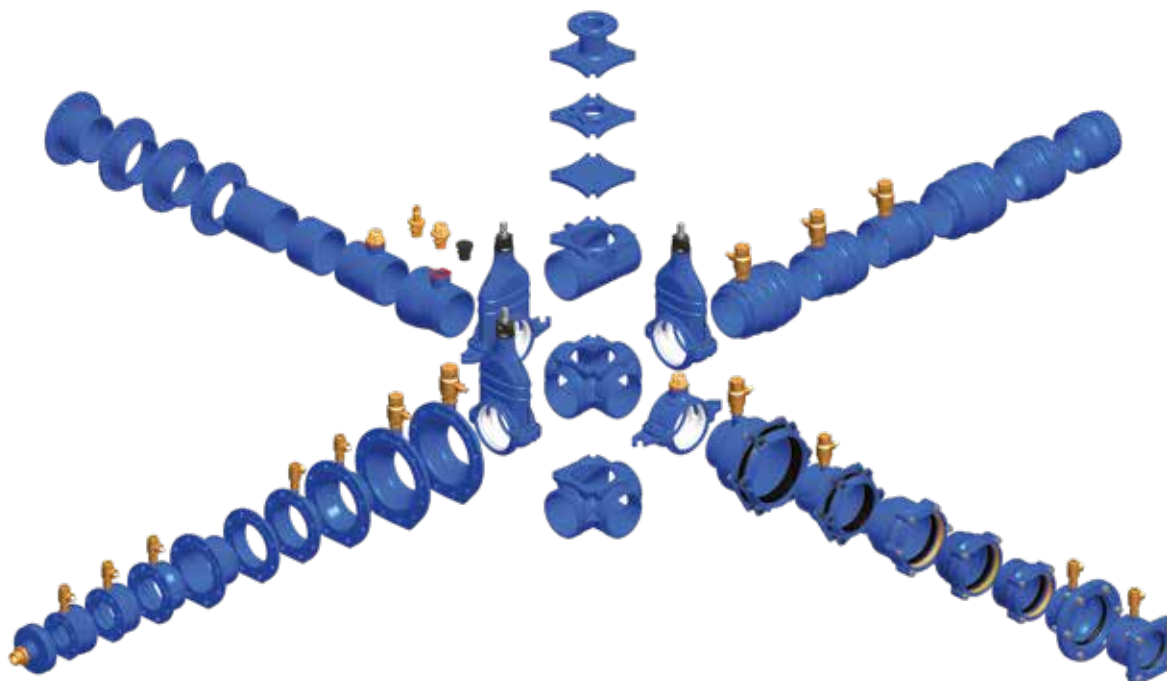

Aquosus® sluseventiler AQ3

Serienr. 02-04

Materialspekifikasjon

Materialspekifikasjon		
Pos	Detalj	Materiale
1	Ventilhus	EN 1563-GJS 500-7
2	Spindelmutter	Avsinkeringsbestandig messing CW511L (Alt. AISI 904L for Duplex)
3	Sluse	AISI 316
4	Glidebrikker	POM
5	Tetningsinnsats	TPR - Termoplastisk Gummi
6	Flens	EN 1563-GJS 500-7
7	Bunndeksel	EN 1563-GJS 500-7
8	Bolter	St 8.8 DIN912
9	Nedre glidelager	POM
10	Øvre glidelager	POM
11	Spindel*	AISI 420 (Alternativt AISI 316 eller Duplex 22 CR (EN 1.4462)
12	O-ringer	EPDM
13	O-ringer	EPDM
14	Pakningsholder	Avsinkeringsbestandig messing CW511L (alt AISI 904L for Duplex)
15	Plast topp	PP
16	Klistremerke	Blå for HL , rød for VL
17	O-ring	EPDM

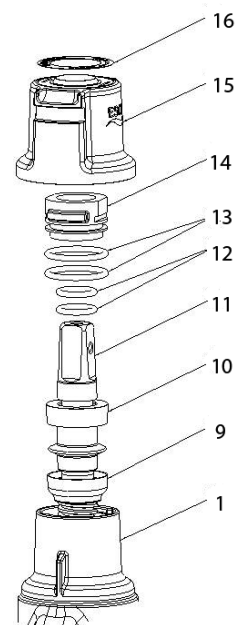

Karakteristikk

Serviceuttak Aquosus® ventiler med flenser	
DN mm	Tommer
80	3/4"
100	3/4"
125	1"
150	1"
200	1"

Spindeltopp DN 80 - 200					
DN	B	H	h	Ød	
65	17,3	38	17	7	
80	17,3	38	17	7	
100	19,3	38	17	7	
150	19,3	38	17	7	
200	24,3	49	18,5	8	

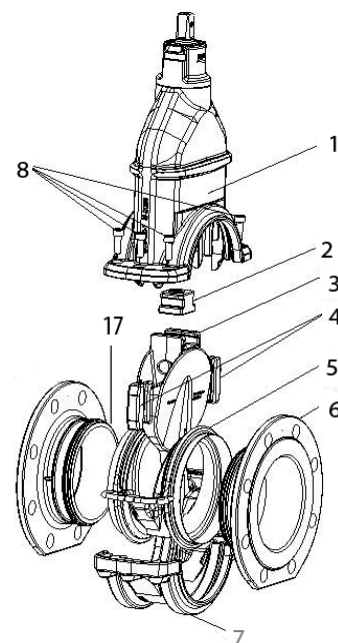

Aquosus® sluseventiler AQ3

Serienr. 20-04

AQ3 og AQ4 med AISI 420 spindel ,serviceventiler, brannventilavstikker og 8.8 varmgalvaniserte bolter til brannventilavstikk, HL

NRF nr.	DN	Flense- boring	Senterdel	Ventil T rør og ventil kryss
5505641	DN100x80x100	PN10/16	DN100	VENTIL T-RØR AQ3 HL SERVICE VENTIL
5505649	DN100x80x100x80	PN10/16	DN100	VENTIL KRYSS AQ4 HL SERVICE VENTIL
5505562	DN100x100x100	PN10/16	DN100	VENTIL T-RØR AQ3 HL SERVICE VENTIL
5505582	DN100x100x100x100	PN10/16	DN100	VENTIL KRYSS AQ4 HL SERVICE VENTIL
5505642	DN150x100x150	PN10/16	DN150	VENTIL T-RØR AQ3 HL SERVICE VENTIL
5505651	DN150x100x150x100	PN10/16	DN150	VENTIL KRYSS AQ4 HL SERVICE VENTIL
5505563	DN150x150x150	PN10/16	DN150	VENTIL T-RØR AQ3 HL SERVICE VENTIL
5508948	DN150x150x150x100	PN10/16	DN150	VENTIL KRYSS AQ4 HL SERVICE VENTIL
5505583	DN150x150x150x150	PN10/16	DN150	VENTIL KRYSS AQ4 HL SERVICE VENTIL
5505644	DN200x100x200	PN10	DN200	VENTIL T-RØR AQ3 HL SERVICE VENTIL
5505653	DN200x100x200x100	PN10	DN200	VENTIL KRYSS AQ4 HL SERVICE VENTIL
5508961	DN200x150x150	PN10	DN200	VENTIL T-RØR AQ3 HL SERVICE VENTIL
5505643	DN200x150x200	PN10	DN200	VENTIL T-RØR AQ3 HL SERVICE VENTIL
5508951	DN200x150x200x100	PN10	DN200	VENTIL KRYSS AQ4 HL SERVICE VENTIL
5505652	DN200x150x200x150	PN10	DN200	VENTIL KRYSS AQ4 HL SERVICE VENTIL
5505564	DN200x200x200	PN10	DN200	VENTIL T-RØR AQ3 HL SERVICE VENTIL
5508968	DN200x200x200x100	PN10	DN200	VENTIL KRYSS AQ4 HL SERVICE VENTIL
5508971	DN200x200x200x150	PN10	DN200	VENTIL KRYSS AQ4 HL SERVICE VENTIL
5505584	DN200x200x200x200	PN10	DN200	VENTIL KRYSS AQ4 HL SERVICE VENTIL
5508963	DN250x150x250	PN10	DN200	VENTIL T-RØR AQ3 HL SERVICE VENTIL
5508973	DN250x150x250x150	PN10	DN200	VENTIL KRYSS AQ4 HL SERVICE VENTIL
5508954	DN250x200x250	PN10	DN200	VENTIL T-RØR AQ3 HL SERVICE VENTIL
5508953	DN250x200x250x150	PN10	DN200	VENTIL KRYSS AQ4 HL SERVICE VENTIL
5508974	DN250x200x250x200	PN10	DN200	VENTIL KRYSS AQ4 HL SERVICE VENTIL
5508956	DN250x250x250	PN10	DN200	VENTIL T-RØR AQ3 HL SERVICE VENTIL
5508975	DN250x250x250x150	PN10	DN200	VENTIL KRYSS AQ4 HL SERVICE VENTIL
5508955	DN250x250x250x200	PN10	DN200	VENTIL KRYSS AQ4 HL SERVICE VENTIL
5508976	DN250x250x250x250	PN10	DN200	VENTIL KRYSS AQ4 HL SERVICE VENTIL
5508957	DN300x150x300	PN10	DN200	VENTIL T-RØR AQ3 HL SERVICE VENTIL
5508977	DN300x150x300x150	PN10	DN200	VENTIL KRYSS AQ4 HL SERVICE VENTIL
5508964	DN300x200x300	PN10	DN200	VENTIL T-RØR AQ3 HL SERVICE VENTIL
5508978	DN300x200x300x150	PN10	DN200	VENTIL KRYSS AQ4 HL SERVICE VENTIL
5508958	DN300x200x300x200	PN10	DN200	VENTIL KRYSS AQ4 HL SERVICE VENTIL
5508965	DN300x250x300	PN10	DN200	VENTIL T-RØR AQ3 HL SERVICE VENTIL
5508979	DN300x250x300x150	PN10	DN200	VENTIL KRYSS AQ4 HL SERVICE VENTIL
5508981	DN300x250x300x200	PN10	DN200	VENTIL KRYSS AQ4 HL SERVICE VENTIL
5508982	DN300x250x300x250	PN10	DN200	VENTIL KRYSS AQ4 HL SERVICE VENTIL
5508966	DN300x300x300	PN10	DN200	VENTIL T-RØR AQ3 HL SERVICE VENTIL
5508983	DN300x300x300x150	PN10	DN200	VENTIL KRYSS AQ4 HL SERVICE VENTIL
5508984	DN300x300x300x200	PN10	DN200	VENTIL KRYSS AQ4 HL SERVICE VENTIL
5508985	DN300x300x300x250	PN10	DN200	VENTIL KRYSS AQ4 HL SERVICE VENTIL
5508986	DN300x300x300x300	PN10	DN200	VENTIL KRYSS AQ4 HL SERVICE VENTIL

Aquosus® sluseventiler

Serienr. 20-04

AQ3 og AQ4 med AISI 316 syrefast spindel, serviceventiler, brannventilavstikker, og A4 bolter til brannventilavstikk, HL

NRF nr.	DN	Flense- boring	Senterdel	Ventil T rør og ventil kryss
5509641	DN100x80x100	PN10/16	DN100	VENTIL T-RØR AQ3 HL SERVICE VENTIL
5509649	DN100x80x100x80	PN10/16	DN100	VENTIL KRYSS AQ4 HL SERVICE VENTIL
5509562	DN100x100x100	PN10/16	DN100	VENTIL T-RØR AQ3 HL SERVICE VENTIL
5509582	DN100x100x100x100	PN10/16	DN100	VENTIL KRYSS AQ4 HL SERVICE VENTIL
5509642	DN150x100x150	PN10/16	DN150	VENTIL T-RØR AQ3 HL SERVICE VENTIL
5509651	DN150x100x150x100	PN10/16	DN150	VENTIL KRYSS AQ4 HL SERVICE VENTIL
5509563	DN150x150x150	PN10/16	DN150	VENTIL T-RØR AQ3 HL SERVICE VENTIL
5509948	DN150x150x150x100	PN10/16	DN150	VENTIL KRYSS AQ4 HL SERVICE VENTIL
5509583	DN150x150x150x150	PN10/16	DN150	VENTIL KRYSS AQ4 HL SERVICE VENTIL
5509644	DN200x100x200	PN10	DN200	VENTIL T-RØR AQ3 HL SERVICE VENTIL
5509653	DN200x100x200x100	PN10	DN200	VENTIL KRYSS AQ4 HL SERVICE VENTIL
5509961	DN200x150x150	PN10	DN200	VENTIL T-RØR AQ3 HL SERVICE VENTIL
5509643	DN200x150x200	PN10	DN200	VENTIL T-RØR AQ3 HL SERVICE VENTIL
5509951	DN200x150x200x100	PN10	DN200	VENTIL KRYSS AQ4 HL SERVICE VENTIL
5509652	DN200x150x200x150	PN10	DN200	VENTIL KRYSS AQ4 HL SERVICE VENTIL
5509564	DN200x200x200	PN10	DN200	VENTIL T-RØR AQ3 HL SERVICE VENTIL
5509968	DN200x200x200x100	PN10	DN200	VENTIL KRYSS AQ4 HL SERVICE VENTIL
5509971	DN200x200x200x150	PN10	DN200	VENTIL KRYSS AQ4 HL SERVICE VENTIL
5509584	DN200x200x200x200	PN10	DN200	VENTIL KRYSS AQ4 HL SERVICE VENTIL
5509963	DN250x150x250	PN10	DN200	VENTIL T-RØR AQ3 HL SERVICE VENTIL
5509973	DN250x150x250x150	PN10	DN200	VENTIL KRYSS AQ4 HL SERVICE VENTIL
5509954	DN250x200x250	PN10	DN200	VENTIL T-RØR AQ3 HL SERVICE VENTIL
5509953	DN250x200x250x150	PN10	DN200	VENTIL KRYSS AQ4 HL SERVICE VENTIL
5509974	DN250x200x250x200	PN10	DN200	VENTIL KRYSS AQ4 HL SERVICE VENTIL
5509956	DN250x250x250	PN10	DN200	VENTIL T-RØR AQ3 HL SERVICE VENTIL
5509975	DN250x250x250x150	PN10	DN200	VENTIL KRYSS AQ4 HL SERVICE VENTIL
5509955	DN250x250x250x200	PN10	DN200	VENTIL KRYSS AQ4 HL SERVICE VENTIL
5509976	DN250x250x250x250	PN10	DN200	VENTIL KRYSS AQ4 HL SERVICE VENTIL
5509957	DN300x150x300	PN10	DN200	VENTIL T-RØR AQ3 HL SERVICE VENTIL
5509977	DN300x150x300x150	PN10	DN200	VENTIL KRYSS AQ4 HL SERVICE VENTIL
5509964	DN300x200x300	PN10	DN200	VENTIL T-RØR AQ3 HL SERVICE VENTIL
5509978	DN300x200x300x150	PN10	DN200	VENTIL KRYSS AQ4 HL SERVICE VENTIL
5509958	DN300x200x300x200	PN10	DN200	VENTIL KRYSS AQ4 HL SERVICE VENTIL
5509965	DN300x250x300	PN10	DN200	VENTIL T-RØR AQ3 HL SERVICE VENTIL
5509979	DN300x250x300x150	PN10	DN200	VENTIL KRYSS AQ4 HL SERVICE VENTIL
5509981	DN300x250x300x200	PN10	DN200	VENTIL KRYSS AQ4 HL SERVICE VENTIL
5509982	DN300x250x300x250	PN10	DN200	VENTIL KRYSS AQ4 HL SERVICE VENTIL
5509966	DN300x300x300	PN10	DN200	VENTIL T-RØR AQ3 HL SERVICE VENTIL
5509983	DN300x300x300x150	PN10	DN200	VENTIL KRYSS AQ4 HL SERVICE VENTIL
5509984	DN300x300x300x200	PN10	DN200	VENTIL KRYSS AQ4 HL SERVICE VENTIL
5509985	DN300x300x300x250	PN10	DN200	VENTIL KRYSS AQ4 HL SERVICE VENTIL
5509986	DN300x300x300x300	PN10	DN200	VENTIL KRYSS AQ4 HL SERVICE VENTIL